

# ***FM Stereo FM/AM Receiver***

---

Operating Instructions

***STR-DK5***

## WARNING

**To reduce the risk of fire or electric shock, do not expose this apparatus to rain or moisture.**

To prevent fire, do not cover the ventilation of the apparatus with newspapers, table-cloths, curtains, etc. And don't place lighted candles on the apparatus.

To prevent fire or shock hazard, do not place objects filled with liquids, such as vases, on the apparatus.

Do not install the appliance in a confined space, such as a bookcase or built-in cabinet.



Don't throw away batteries with general house waste; dispose of them correctly as chemical waste.

## About This Manual

- The instructions in this manual are for model STR-DK5. Check your receiver's model number by looking at the lower right corner of the front panel. In this manual, the models of area code SP is used for illustration purposes unless stated otherwise.
- The instructions in this manual describe the controls on the receiver. You can also use the controls on the supplied remote if they have the same or similar names as those on the receiver. For details on the use of your remote, see pages 33–36.

### About area codes

The area code of the receiver you purchased is shown on the lower portion of the rear panel (see the illustration below).

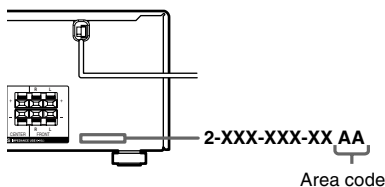

Any differences in operation, according to the area code, are clearly indicated in the text, for example, “Models of area code AA only”.

This receiver incorporates Dolby\* Digital and Pro Logic Surround and the DTS\*\* Digital Surround System.

\* Manufactured under license from Dolby Laboratories.

“Dolby”, “Pro Logic” and the double-D symbol are trademarks of Dolby Laboratories.

\*\* “DTS” and “DTS Digital Surround” are registered trademarks of Digital Theater Systems, Inc.

# Table of Contents

---

## Getting Started

1: Check how to hookup your components .....	4
1a: Connecting components with digital audio output jacks .....	6
1b: Connecting components with only analog audio jacks .....	8
2: Connecting the antennas .....	9
3: Connecting speakers .....	10
4: Connecting the AC power cord .....	12
5: Setting up the speakers .....	13
6: Adjusting the speaker levels and balance .....	16
— TEST TONE .....	

---

## Amplifier Operation

Selecting the component .....	17
Listening to FM/AM radio .....	17
Presetting radio stations .....	18
Changing the display .....	19
About the display .....	20

---

## Enjoying Surround Sound

Using only the front speakers .....	21
Enjoying higher fidelity sound .....	21
— AUTO FORMAT DIRECT .....	
Selecting a sound field .....	22

---

## Enjoying Karaoke

Using Karaoke .....	24
Advanced karaoke settings .....	25

---

## Advanced Adjustments and Settings

Switching the audio input mode for digital components .....	27
— INPUT MODE .....	
Customizing sound fields .....	27
Advanced settings .....	29

---

## Other Operations

Naming preset stations and inputs .....	30
Using the Sleep Timer .....	30
Enjoying the lighting effects .....	31
Optional karaoke scoring system .....	32

---

## Operations Using the Remote RM-AAU002

Before you use your remote .....	33
Remote button description .....	33
Changing the factory setting of an input button .....	36

---

## Additional Information

Precautions .....	37
Troubleshooting .....	38
Specifications .....	40
List of button locations and reference pages .....	42
Index .....	43

# 1: Check how to hookup your components

Steps 1a through 1b beginning on page 6 describe how to hook up your components to this receiver. Before you begin, refer to “Connectable components” below for the pages which describe how to connect each component.

After hooking up all your components, proceed to “2: Connecting the antennas” (page 9).

## Connectable components

Component to be connected	Page
DVD player	
With digital audio output <sup>a)</sup>	6
With analog audio output only <sup>b)</sup>	8
Satellite tuner	
With analog audio output only <sup>b)</sup>	8
Super Audio CD/CD player	
With digital audio output <sup>a)</sup>	7
With analog audio output only <sup>b)</sup>	8
VCR	8

<sup>a)</sup> Model with a DIGITAL OPTICAL OUTPUT or DIGITAL COAXIAL OUTPUT jack, etc.

<sup>b)</sup> Model equipped only with AUDIO OUT L/R jacks, etc.

## Required cords

The hookup diagrams on the subsequent pages assume the use of the following optional connection cords (**A** to **C**) (not supplied).

### **A** Audio cord

White (L)  
Red (R)



### **C** Coaxial digital cord



### **B** Optical digital cord



### Notes

- Turn off the power to all components before making any connections.
- Be sure to make connections firmly to avoid hum and noise.
- When connecting an audio cord, be sure to match the color-coded pins to the appropriate jacks on the components: white (left, audio) to white; and red (right, audio) to red.
- When connecting optical digital cords, insert the cord plugs straight in until they click into place.
- Do not bend or tie optical digital cords.

# 1a: Connecting components with digital audio output jacks

## Hooking up a DVD player

For details on the required cords (**A**–**C**), see page 5.

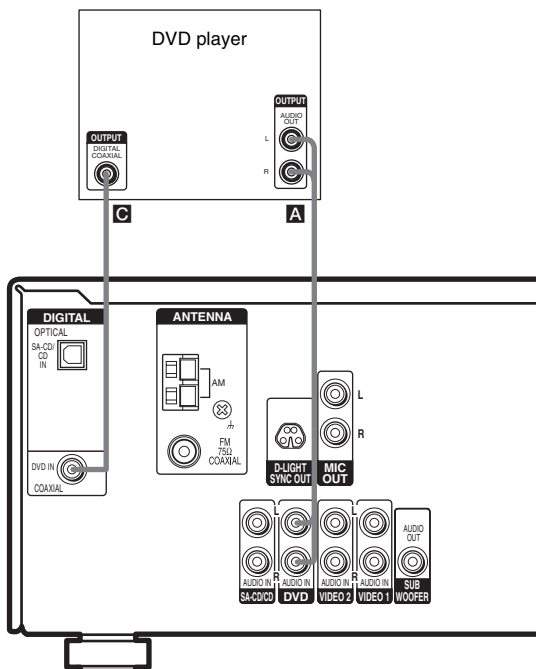

## Hooking up a Super Audio CD/CD player

For details on the required cords (**A**–**C**), see page 5.

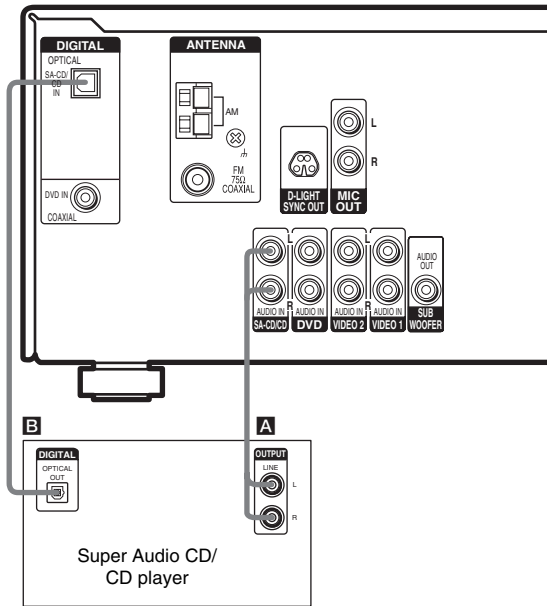

### Tip

All the digital audio jacks are compatible with 32 kHz, 44.1 kHz, 48 kHz and 96 kHz sampling frequencies.

### Note

The sound is not output when you play a Super Audio CD on the Super Audio CD player connected to the SA-CD/CD OPTICAL IN jack on this receiver. Connect to the analog input jacks (SA-CD/CD IN jacks). Refer to the operating instructions supplied with the Super Audio CD player.

# 1b: Connecting components with only analog audio jacks

For details on the required cords (**A-C**), see page 5.

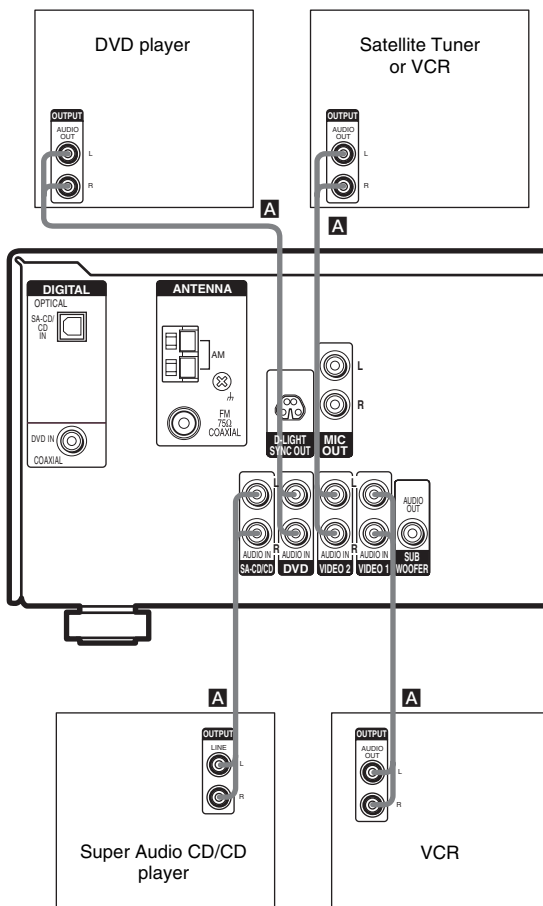



## 2: Connecting the antennas

Connect the supplied AM loop antenna and FM wire antenna.

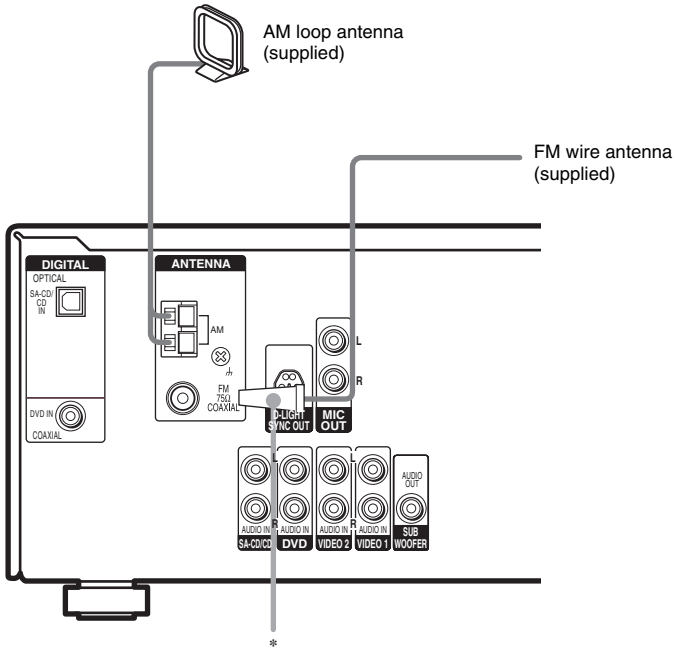

\* The shape of the connector varies depending on the area code.

### Notes

- To prevent noise pickup, keep the AM loop antenna away from the receiver and other components.
- Be sure to fully extend the FM wire antenna.
- After connecting the FM wire antenna, keep it as horizontal as possible.

### 3: Connecting speakers

Connect your speakers to the receiver. This receiver allows you to use a 5.1 channel speaker system. To fully enjoy theater-like multi channel surround sound requires five speakers (two front speakers, a center speaker, and two surround speakers) and a sub woofer (5.1 channel).

#### Example of 5.1 channel speaker system configuration

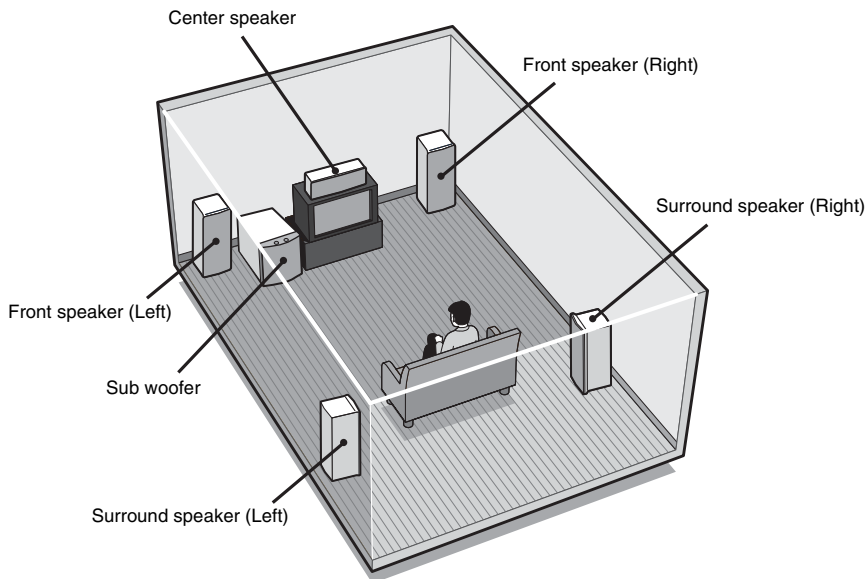

#### Tip

Since the sub woofer does not emit highly directional signals, you can place it wherever you want.

## Required cords

### A Speaker cords (not supplied)

(+)  
(-)



### B Monaural audio cord (not supplied)

Black

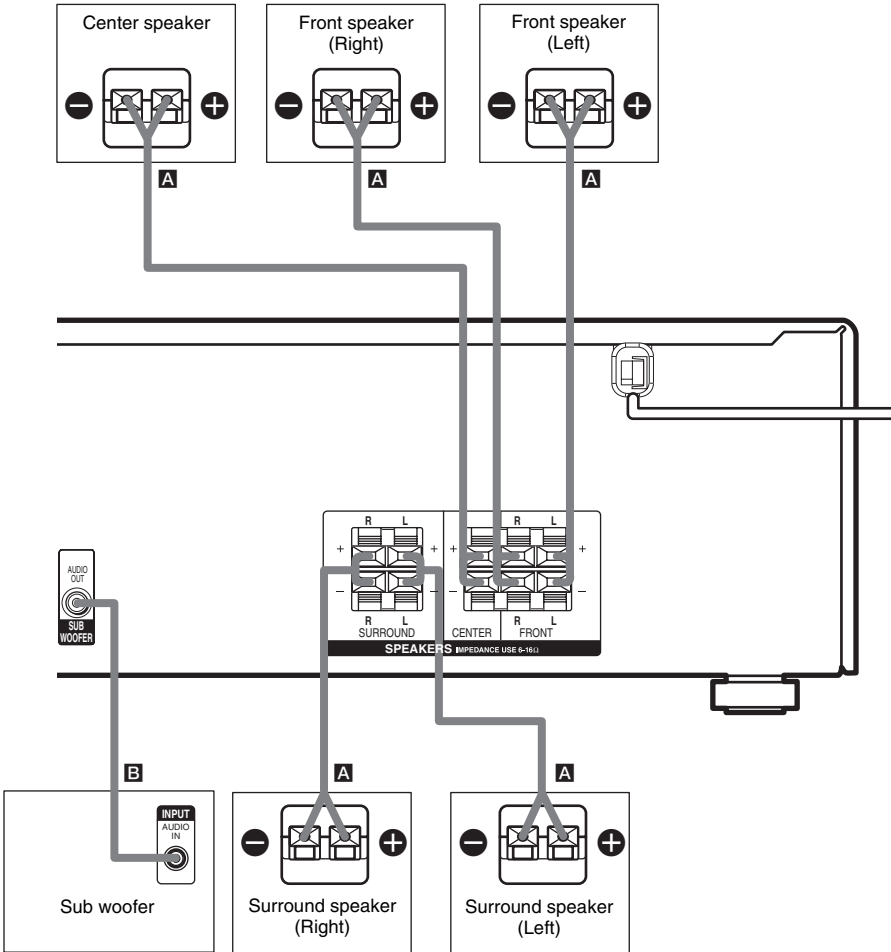

## 4: Connecting the AC power cord

### Connecting the AC power cord

Connect the AC power cord to a wall outlet.

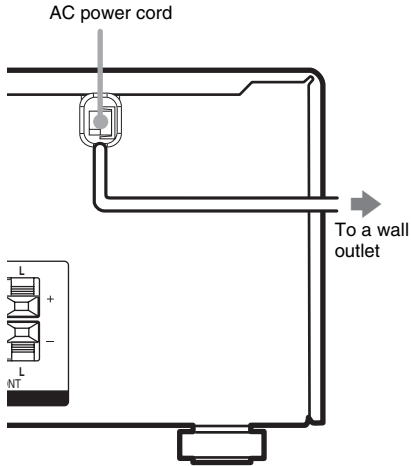

#### Note

Install this system so that the power cord can be unplugged from the wall socket immediately in the event of trouble.

## 5: Setting up the speakers

You can use the SETUP menu to set the size, distance and location of the speakers connected to this receiver.

Use the remote for the operation.

- 1** Press I/⏻ to turn on the receiver.
- 2** Press MAIN MENU repeatedly to select “<SET UP>”.

- 3** Press ↑ or ↓ repeatedly to select the parameter you want to adjust.

For details, see “SETUP menu parameters” on page 13.

### Note

Some speaker setup items may appear dimmed in the display. This means that they have been adjusted automatically due to other speaker settings or may not be adjustable.

- 4** Press ← or → repeatedly to select the setting you want.

The setting is entered automatically.

### Note

Press ENTER if you select the setting for “SP. PAT. X –X”.

- 5** Repeat steps 3 and 4 until you have set all of the items that follow.

## SETUP menu parameters

The initial setting is underlined.

### ■ XXXX SET (Speaker easy setup)

- EASY  
If you want to set up your speakers automatically, select “EASY SET”. You can select a pre-defined speaker pattern (see the supplied “Easy Setup Guide”).
- NORM  
If you want to adjust the settings of each speaker manually, select “NORM SET”.

### ■ SP. PAT. X –X (Speaker setup pattern)

When you select “EASY SET”, select the speaker setup pattern. Press ◀ or ▶ repeatedly to select the speaker setup pattern and press ENTER to enter the selection. Check your speaker pattern using the supplied “Easy Setup Guide”.

### ■ S.W. XXX (Sub woofer selection)

- YES  
If you connect a sub woofer, select “YES”.
- NO

If you did not connect a sub woofer, select “NO”. The front speakers are automatically set to “LARGE” and you cannot change this setting. This activates the bass redirection circuitry and outputs the LFE signals from other speakers.

### Note

In order to take full advantage of the Dolby Digital bass redirection circuitry, we recommend that you set the cut off frequency on the sub woofer as high as possible.

### ■ XXXXX (Front speakers size)

- LARGE  
If you connect large speakers that will effectively reproduce bass frequencies, select “LARGE”. Normally, select “LARGE”.
- SMALL

If the sound is distorted, or you feel a lack of surround effects when using multi channel surround sound, select “SMALL” to activate the bass redirection circuitry and output the front channel bass frequencies from the sub woofer. When the front speakers are set to “SMALL”, the center and surround speakers are also automatically set to “SMALL” (unless previously set to “NO”).

### ■ XXXXX (Center speaker size)

#### • **LARGE**

If you connect a large speaker that will effectively reproduce bass frequencies, select “LARGE”. Normally, select “LARGE”.

However, if the front speakers are set to “SMALL”, you cannot set the center speaker to “LARGE”.

#### • **SMALL**

If the sound is distorted, or you feel a lack of surround effects when using multi channel surround sound, select “SMALL” to activate the bass redirection circuitry and output the center channel bass frequencies from the front speakers (if set to “LARGE”) or sub woofer.<sup>a)</sup>

#### • **NO**

If you did not connect a center speaker, select “NO”. The sound of the center channel will be output from the front speakers.<sup>b)</sup>

### ■ XXXXX (Surround speakers size)

#### • **LARGE**

If you connect large speakers that will effectively reproduce bass frequencies, select “LARGE”. Normally, select “LARGE”.

However, if the front speakers are set to “SMALL”, you cannot set the surround speakers to “LARGE”.

#### • **SMALL**

If the sound is distorted, or you feel a lack of surround effects when using multi channel surround sound, select “SMALL” to activate the bass redirection circuitry and output the surround channel bass frequencies from the sub woofer or other “LARGE” speakers.

#### • **NO**

If you did not connect surround speakers, select “NO”.<sup>c)</sup>

### Tips

• a)–c) correspond to the following Dolby Pro Logic modes

- a) NORMAL
- b) PHANTOM
- c) 3 STEREO

• The “LARGE” and “SMALL” settings for each speaker determine whether the internal sound processor will cut the bass signal from that channel. When the bass is cut from a channel, the bass redirection circuitry sends the corresponding bass frequencies to the sub woofer or other “LARGE” speakers.

However, since bass sounds have a certain amount of directionality, it is best not to cut them, if possible. Therefore, even when using small speakers, you can set them to “LARGE” if you want to output the bass frequencies from that speaker. On the other hand, if you are using a large speaker, but prefer not to have bass frequencies output from that speaker, set it to “SMALL”.

If the overall sound level is lower than you prefer, set all speakers to “LARGE”.

### ■ **DIST. X.X m** (Front speaker distance)

Initial setting: 3.0 m

Lets you set the distance from your listening position to the front speakers (A). You can adjust from 1.0 meter to 7.0 meters in 0.1 meter steps.

If both front speakers are not placed an equal distance from your listening position, set the distance to the closest speaker.

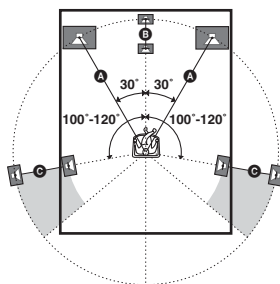

## ■ DIST. X.X m (Center speaker distance)

Initial setting: 3.0 m

Lets you set the distance from your listening position to the center speaker. Center speaker distance should be set from a distance equal to the front speaker distance (**A** on page 14) to a distance 1.5 meters closer to your listening position (**B** on page 14).

## ■ DIST. X.X m (Surround speaker distance)

Initial setting: 3.0 m

Lets you set the distance from your listening position to the surround speakers. Surround speaker distance should be set from a distance equal to the front speaker distance (**A** on page 14) to a distance 4.5 meters closer to your listening position (**C** on page 14).

If both surround speakers are not placed an equal distance from your listening position, set the distance to the closest speaker.

### Tip

The receiver lets you to input the speaker position in terms of distance. However, it is not possible to set the center speaker further than the front speakers. Also, the center speaker cannot be set more than 1.5 meters closer than the front speakers.

Likewise, the surround speakers cannot be set further away from the listening position than the front speakers. And they can be no more than 4.5 meters closer.

This is because incorrect speaker placement is not conducive to the enjoyment of surround sound. Please note that, setting the speaker distance closer than the actual location of the speakers will cause a delay in the output of the sound from that speaker. In other words, the speaker will sound like it is further away.

For example, setting the center speaker distance 1–2 meters closer than the actual speaker position will create a fairly realistic sensation of being “inside” the screen. If you cannot obtain a satisfactory surround effect because the surround speakers are too close, setting the surround speaker distance closer (shorter) than the actual distance will create a larger sound stage. Adjusting these parameter while listening to the sound often results in much better surround sound. Give it a try!

## ■ XXXX/XX (Surround speaker position)\*

Lets you specify the location of your surround speakers for proper implementation of the surround effects in the Cinema Studio EX modes (page 22).

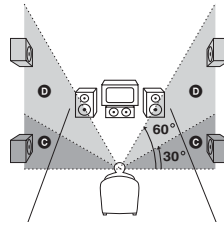
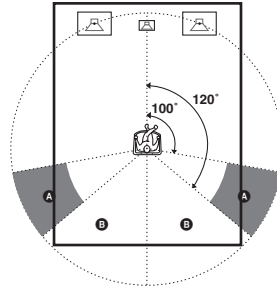

- SIDE/LO  
Select if the location of your surround speakers corresponds to section **A** and **C**.
- SIDE/Hi  
Select if the location of your surround speakers corresponds to section **A** and **D**.
- BEHD/LO  
Select if the location of your surround speakers corresponds to section **B** and **C**.
- BEHD/Hi  
Select if the location of your surround speakers corresponds to section **B** and **D**.

\* This setup item is not available when the surround speakers size parameter is set to “NO”.

### Tip

Surround speaker position is designed specifically for implementation of the Cinema Studio EX modes.

For other sound fields, speaker position is not so critical. Those sound fields were designed under the premise that the surround speakers would be located behind the listening position, but presentation remains fairly consistent even with the surround speakers positioned at a rather wide angle. However, if the speakers are pointing toward the listener from the immediate left and right of the listening position, the surround effects becomes unclear unless set to “SIDE/LO” or “SIDE/HI”.

Nevertheless, each listening environment has many variables, such as wall reflections, and you may obtain better results using “BEHD/HI” if your speakers are located high above the listening position, even if they are to the immediate left and right.

Therefore, although it may result in a setting contrary to the above explanation, we recommend that you playback multi channel surround encoded software and select the setting that provides a good sense of spaciousness and that best succeeds in forming a cohesive space between the surround sound from the surround speakers and the sound of the front speakers. If you are not sure which sounds best, select “BEHD/LO” or “BEHD/HI” and then use the speaker distance parameter and speaker level adjustments to obtain proper balance.

### ■ SP > XXX Hz (Speaker crossover frequency)\*

Initial setting: 100 Hz

Lets you adjust the bass crossover frequency of speakers in SETUP menu. You can adjust the bass crossover frequency from 40 Hz to 160 Hz in 9 steps.

\* This setup item is only available when at least one speaker is set to “SMALL” and the corresponding speaker segment flashes in the display.

## 6: Adjusting the speaker levels and balance

### — TEST TONE

Adjust the speaker levels and balance while listening to the test tone from your listening position.

Use the remote for the operation.

### Tip

The receiver employs a test tone with a frequency centered at 800 Hz.

**1** Press I/⏻ to turn on the receiver.

**2** Press TEST TONE.

“T. TONE” appears in the display.

The test tone is output from each speaker in sequence and the display will automatically change as follows:

LEFT (Front left) → CENTER (Center) →  
RIGHT (Front right) → SURR R  
(Surround right) → SURR L (Surround  
left) → S. WOOFER (Sub woofer)

**3** Adjust the speaker levels and balance using the LEVEL menu so that the level of the test tone sounds the same from each speaker.

For details on the LEVEL menu settings, see page 27.

### Tips

- To adjust the level of all speakers at the same time, press MASTER VOL +/- on the remote or turn MASTER VOLUME on the receiver.
- The adjusted value are shown in the display during adjustment.

**4** Press TEST TONE again after adjustment.

The test tone turns off.

### Note

The test tone will automatically cancel when you activate the karaoke function.



## Amplifier Operation

### Selecting the component

#### 1 Turn INPUT SELECTOR to select the input.

The selected input appears in the display.

To select the	Display
VCR	VIDEO 1 or VIDEO 2
Satellite tuner	VIDEO 2
DVD player	DVD
Super Audio CD or CD player	SA-CD/CD
Built-in tuner (FM)	FM and frequency
Built-in tuner (AM)	AM and frequency

#### 2 Turn on the component and start playback.

##### Note

If you select any video components, set the TV's video input to match the component you selected.

#### 3 Turn MASTER VOLUME to adjust the volume.

##### Note

To avoid damaging your speakers, make sure that you turn down the volume before you turn off the receiver.

### To mute the sound

#### Press MUTING on the remote.

The muting function will be canceled when you do the following.

- Press MUTING on the remote again.
- Turn the power off.
- Increase the volume.

## Listening to FM/AM radio

You can listen to FM and AM broadcasts through the built-in tuner. Before operation, make sure you have connected the FM and AM antennas to the receiver (see page 9).

##### Tip

The tuning scale differs depending on the area code as shown in the following table. For details on area codes, see page 2.

Area code	FM	AM
SP, VN, TH	50 kHz	9 kHz

### Automatic tuning

If you do not know the frequency of the station you want, you can let the receiver scan all available stations in your area.

#### 1 Turn INPUT SELECTOR to select the FM or AM band.

The last received station is tuned in.

#### 2 Press TUNING + or TUNING –.

Press TUNING + to scan from low to high; press TUNING – to scan from high to low.

The receiver stops scanning whenever a station is received.

### In case of poor FM stereo reception

If the FM stereo reception is poor and "STEREO" flashes in the display, select monaural audio so that the sound will be less distorted.

Use the remote for the operation.

#### 1 Press MAIN MENU repeatedly to select "<TUNER>".

#### 2 Press ↑ or ↓ repeatedly to select "FM AUTO".

#### 3 Press ← or → repeatedly to select "FM MONO".

The FM reception switches to monaural.

##### Tip

You will not be able to enjoy the stereo effect, but the sound will be less distorted. To return to stereo mode, select "FM AUTO" in step 3.

## Direct tuning

You can enter the frequency of the station you want directly.

Use the remote for the operation.

### 1 Press TUNER repeatedly to select the FM or AM band.

The last received station is tuned in.

#### Tip

You can also use the INPUT SELECTOR knob on the receiver.

### 2 Press D.TUNING.

### 3 Press the numeric buttons to enter the frequency.

Example 1: FM 102.50 MHz

Press 1 → 0 → 2 → 5 → 0

Example 2: AM 1,350 kHz

Press 1 → 3 → 5 → 0

If you have tuned in an AM station, adjust the direction of the AM loop antenna for optimum reception.

## If you cannot tune in a station and the entered numbers flash

Make sure you have entered the right frequency. If not, repeat step 3. If the entered numbers still flash, the frequency is not used in your area.

## Presetting radio stations

You can preset up to 30 FM or AM stations. Then you can easily tune in the stations you often listen to.

## Presetting radio stations

### 1 Turn INPUT SELECTOR to select the FM or AM band.

The last received station is tuned in.

### 2 Tune in the station that you want to preset using automatic tuning (page 17) or direct tuning (page 18).

### 3 Press MEMORY/ENTER.

“MEMORY” lights up in the display for a few seconds. Do steps 4 to 5 before the display goes out.

### 4 Press TUNING + or TUNING – repeatedly to select a preset station number.

Each time you press the button, you can select the preset station number as follows:

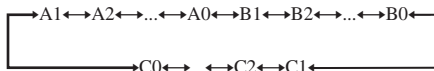

If “MEMORY” turns off before you select the preset station number, start again from step 3.

#### Tip

You can also use the remote to select a preset station number. Press SHIFT repeatedly to select a memory page (A, B or C) and then press the numeric buttons to select a preset number.

### 5 Press MEMORY/ENTER again.

The station is stored to the selected preset number.

If “MEMORY” turns off before you press MEMORY/ENTER, start again from step 3.

### 6 Repeat steps 2 to 5 to preset another station.

## Tuning to preset stations

Use the remote for the operation.

- 1 Press TUNER repeatedly to select the FM or AM band.**

The last received station is tuned in.

**Tip**

You can also use the INPUT SELECTOR knob on the receiver.

- 2 Press PRESET + or PRESET – repeatedly to select the preset station you want.**

Each time you press the button, you can select the preset station as follows:

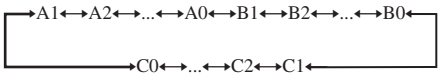

### To select the preset station directly

**Press the numeric buttons on the remote.**

The preset station of the selected number in the current memory page is tuned in. Press SHIFT repeatedly on the remote to change the memory page.

## Changing the display

### Changing the information in the display

You can check the sound field etc. by changing the information in the display.

**Press DISPLAY repeatedly.**

Each time you press DISPLAY, the display will change cyclically as follows.

Current karaoke score<sup>1)</sup> → Index name of the input<sup>2)</sup> → Selected input → Sound field currently applied

**When the tuner is selected**

Index name of preset station<sup>2)</sup> → Frequency → Sound field currently applied

- 1) Karaoke score appears only when you have activated the karaoke function and scoring system.
- 2) Index name appears only when you have assigned one to the input or preset station (page 30). Index name does not appear when only blank spaces have been entered, or it is the same as the input name.

## About the display

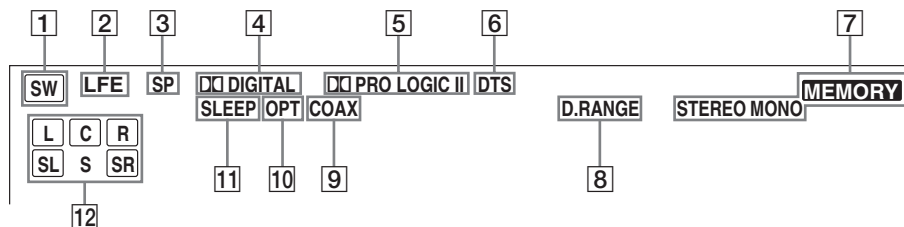

- 1 SW:** Lights up when sub woofer selection is set to “YES” (page 13) and the audio signal is output from the SUB WOOFER jack.
- 2 LFE:** Lights up when the disc contains the LFE (Low Frequency Effect) channel and the LFE channel signal is actually being reproduced.
- 3 SP:** Lights up when you turn on the receiver.
- 4  DIGITAL:** Lights up when the receiver is decoding signals recorded in the Dolby Digital format.
- Note**  
When playing a Dolby Digital format disc, be sure that you have made digital connections and that INPUT MODE is not set to “ANALOG” (page 27).
- 5  PRO LOGIC II:** “ PRO LOGIC” lights up when the receiver applies Pro Logic processing to 2 channel signals in order to output the center and surround channel signals. “ PRO LOGIC II” lights up when the Pro Logic II Movie/Music decoder is activated. However, these indicators do not light up if both the center and surround speakers are set to “NO” and you select a sound field using the A.F.D. button.
- 6 DTS:** Lights up when DTS signals are input.
- Note**  
When playing a DTS format disc, be sure that you have made digital connections and that INPUT MODE is not set to “ANALOG” (page 27).
- 7 Tuner indicators:** Lights up when using the receiver to tune in radio stations, etc. See pages 17–19 for tuner operations.
- 8 D.RANGE:** Lights up when dynamic range compression is activated (page 28).
- 9 COAX:** Lights up when the source signal is a digital signal being input through the COAXIAL terminal.
- 10 OPT:** Lights up when the source signal is a digital signal being input through the OPTICAL terminal.
- 11 SLEEP:** Lights up when sleep timer is activated.
- 12 Playback channel indicators:** The letters (L, C, R, etc.) indicate the channels being played back. The boxes around the letters vary to show how the receiver downmixes the source sound (based on the speakers settings). L (Front Left), R (Front Right), C (Center (monaural)), SL (Surround Left), SR (Surround Right), S (Surround (monaural) or the surround components obtained by Pro Logic processing)
- Example:**  
Recording format (Front /Surround): 3/2  
Output channel: When the surround speakers size parameter is set to “NO”  
Sound Field: A.F.D. AUTO



## Enjoying Surround Sound

### Using only the front speakers

In this mode, the receiver outputs the sound from the front left/right speakers only. There is no sound from the sub woofer.

### Listening to 2 channel stereo sources (2CH STEREO)

Standard 2 channel stereo sources completely bypass the sound field processing and multi channel surround formats are downmixed to 2 channel.

#### Press 2CH.

“2CH ST.” appears in the display and the receiver switches to the 2CH STEREO mode.

#### Note

No sound is output from the sub woofer in the 2CH STEREO mode. To listen to the 2 channel stereo sources using the front left/right speakers and a sub woofer, set A.F.D. mode to “A.F.D. AUTO”.

## Enjoying higher fidelity sound

### — AUTO FORMAT DIRECT

The Auto Format Direct (A.F.D.) mode allows you to select the decoding mode you want for your audio sound.

A.F.D. mode (Display)	Decoding mode
A.F.D. AUTO (A.F.D. AUTO)	As encoded
PRO LOGIC (DOLBY PL)	Dolby Pro Logic
PRO LOGIC II MOVIE (PLII MV)	Dolby Pro Logic II
PRO LOGIC II MUSIC (PLII MS)	
MULTI STEREO (MULTI ST.)	

#### Notes

- When the karaoke function is activated, you can only select “A.F.D. AUTO”.
- If you activate the karaoke function while A.F.D. mode is operating, the system will automatically switch to “A.F.D. AUTO”.

### Decoding the input audio signal automatically

In this mode, the receiver automatically detects the type of audio signal being input (Dolby Digital, DTS, standard 2 channel stereo, etc.) and performs the proper decoding if necessary. This mode presents the sound as it was recorded/encoded, without adding any surround effects. However, if there are no low frequency signals (Dolby Digital LFE, etc.) it will generate a low frequency signal for output to the sub woofer.

#### Press A.F.D. repeatedly to select “A.F.D. AUTO”.

The receiver automatically detects the type of audio signal being input and performs the proper decoding if necessary.

## Enjoying stereo sound in multi channel (2 channel decoding mode)

This mode lets you specify the type of decoding for 2 channel audio sources. This receiver can reproduce 2 channel sound in 5 channels through Dolby Pro Logic II; or 4 channels through Dolby Pro Logic.

**Press A.F.D. repeatedly to select the 2 channel decoding mode.**

The selected type of decoding appears in the display.

### ■ DOLBY PL (PRO LOGIC)

Performs Dolby Pro Logic decoding. The source recorded in 2 channel is decoded into 4.1 channels.

### ■ PLII MV (PRO LOGIC II MOVIE)

Performs Dolby Pro Logic II Movie mode decoding. This setting is ideal for movies encoded in Dolby Surround. In addition, this mode can reproduce sound in 5.1 channel when watching videos of overdubbed or old movies.

### ■ PLII MS (PRO LOGIC II MUSIC)

Performs Dolby Pro Logic II Music mode decoding. This setting is ideal for normal stereo sources such as CDs.

### ■ MULTI ST. (MULTI STEREO)

Outputs the 2 channel left/right signals from all speakers. The sound of speakers may not output depending on the speakers settings.

## If you connect a sub woofer

When the audio signal is 2 channel stereo or if the source signal does not include a LFE signal, the receiver generates a low frequency signal for output to the sub woofer.

## Selecting a sound field

You can take advantage of surround sound simply by selecting one of the receiver's pre-programmed sound fields. They bring the exciting and powerful sound of movie theaters and concert halls into your home.

## Selecting a sound field for movies

**Press MOVIE repeatedly to select the sound field you want.**

The selected sound field appears in the display.

Sound field	Display
CINEMA STUDIO EX A <b>DCS</b>	C.ST.EX A
CINEMA STUDIO EX B <b>DCS</b>	C.ST.EX B
CINEMA STUDIO EX C <b>DCS</b>	C.ST.EX C

## About DCS (Digital Cinema Sound)

Sound fields with **DCS** marks use DCS technology.

DCS is the concept name of the surround technology for home theater developed by Sony. DCS uses the DSP (Digital Signal Processor) technology to reproduce the sound characteristics of an actual cinema cutting studio in Hollywood.

When played at home, DCS will create a powerful theater effect that mimics the artistic combination of sound and action as envisioned by the movie director.

### ■ C.ST.EX A (CINEMA STUDIO EX A) **DCS**

Reproduces the sound characteristics of the Sony Pictures Entertainment "Cary Grant Theater" cinema production studio. This is a standard mode, great for watching most any type of movies.

### ■ C.ST.EX B (CINEMA STUDIO EX B) **DCS**

Reproduces the sound characteristics of the Sony Pictures Entertainment "Kim Novak Theater" cinema production studio. This mode is ideal for watching science-fiction or action movies with lots of sound effects.

## ■ C.ST.EX C (CINEMA STUDIO EX C) DCS

Reproduces the sound characteristics of the Sony Pictures Entertainment scoring stage. This mode is ideal for watching musicals or films where orchestra music is featured in the soundtrack.

### About CINEMA STUDIO EX modes

CINEMA STUDIO EX modes are suitable for watching motion picture DVDs (etc.), with multi channel surround effects. You can reproduce the sound characteristics of Sony Pictures Entertainment's dubbing studio in your home.

The CINEMA STUDIO EX modes consist of the following three elements.

- **Virtual Multi Dimension**  
Creates 5 sets of virtual speakers from a single pair of actual surround speakers.
- **Screen Depth Matching**  
Creates the sensation that the sound is coming from inside the screen like in theaters.
- **Cinema Studio Reverberation**  
Reproduces the type of reverberation found in theaters.

The CINEMA STUDIO EX modes integrate these three elements simultaneously.

#### Notes

- The effects provided by the virtual speakers may cause increased noise in the playback signal.
- When listening with sound fields that employ the virtual speakers, you will not be able to hear any sound coming directly from the surround speakers.

## Selecting a sound field for music

Press **MUSIC** repeatedly to select the sound field you want.

The selected sound field appears in the display.

Sound field	Display
HALL	HALL
JAZZ CLUB	JAZZ
LIVE CONCERT	CONCERT

## ■ HALL

Reproduces the acoustics of a classical concert hall.

## ■ JAZZ (JAZZ CLUB)

Reproduces the acoustics of a jazz club.



## ■ CONCERT (LIVE CONCERT)

Reproduces the acoustics of a 300-seat live house.

### To turn off the surround effect

Press **2CH** to select "2CH ST." or press **A.F.D.** repeatedly to select "A.F.D. AUTO".

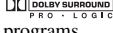
#### Tips

- The receiver lets you apply the last selected sound field to an input whenever it is selected (Sound Field Link). For example, if you select **HALL** for the SA-CD/CD input, then change to a different input and then return to SA-CD/CD, **HALL** will automatically be applied again.
- You can identify the encoding format of DVD software, etc. by looking at the logo on the package.
  -  : Dolby Digital discs
  -  : Dolby Surround encoded programs
  -  : DTS Digital Surround encoded programs

#### Notes

- Sound fields do not function for the signals with a sampling frequency of more than 48 kHz.
- When one of the following sound fields are selected no sound is output from the sub woofer if all the speakers are set to "LARGE" in the SETUP menu. However, the sound will be output from the sub woofer if the digital input signal contains LFE (Low Frequency Effect) signals, or if the front, center, or surround speakers are set to "SMALL".
  - **HALL**
  - **JAZZ CLUB**
  - **LIVE CONCERT**
- The center channel sound will be downmixed to front channel and output from the front speakers when the karaoke function is activated and a sound field is selected using the **MOVIE** button.

## Enjoying Karaoke

### Using Karaoke

You can enjoy karaoke by singing along with the selected input. Before operation, make sure you have set the receiver to karaoke function.

#### Note

The karaoke function cannot be used when you select Tuner FM/AM.

**1 Turn INPUT SELECTOR to select the input you want.**

**2 Press KARAOKE ON/OFF repeatedly to select “KARA ON”.**

The KARAOKE ON/OFF indicator lights up and the karaoke function is activated.

#### Tip

You can also use the KARAOKE menu to activate the karaoke function (page 25).

**3 Turn MIC 1 VOL or MIC 2 VOL to MIN to reduce the microphone volume level.**

**4 Connect a microphone to MIC 1 or MIC 2 jack.**

#### Tip

You need to connect 2 microphones if you want to sing duet.

**5 Start playing the source and turn MUSIC VOLUME to adjust the music volume level.**

For details, see “Adjusting the music” on page 24.

**6 Turn MIC 1 VOL or MIC 2 VOL to adjust the microphone volume level.**

**7 Turn MIC 1 Tone knobs or MIC 2 Tone knobs to adjust the microphone tone level.**

You can adjust microphone tone level in 3 bands – Low, Medium and High.

**8 Turn ECHO to adjust the microphone echo effect.**

To cancel the echo effect, turn ECHO to MIN.

#### Note

The same echo level is applied to both MIC 1 and MIC 2.

### To cancel the karaoke function

The karaoke function will be canceled when you do the following.

- Press KARAOKE ON/OFF repeatedly to select “KARA OFF” (the indicator turns off).
- Set “KARA XXX” in the KARAOKE menu to “KARA OFF”.
- Select another input.
- Turn the power off.

#### Notes

- You can use the MUSIC VOLUME knob and microphone only when the karaoke function is activated.
- If acoustic feedback (howling) occurs, move the microphone away from the speakers or change the direction of the microphone.

---

## Adjusting the music

You can adjust the music volume level and music tone of the selected input.

### ■ MUSICXXX dB (Music volume level)

Lets you adjust the music volume level relative to the microphone volume level. If the music volume level is higher compared to the microphone volume level, you can

- turn the MUSIC VOLUME counterclockwise to reduce the music volume level, or
- turn the MIC 1 VOL or MIC 2 VOL clockwise to increase the microphone volume level.

### Turn MUSIC VOLUME to adjust the music volume level to suit your preference.

Initial setting: 0 dB

You can adjust the music volume level from –10 dB to +10 dB in 1 dB steps.



**Notes**

- This parameter is valid only when the karaoke function is activated.
- If the music is very loud during karaoke function and you have reduced the volume level using the MUSIC VOLUME knob, be sure to adjust the MASTER VOLUME to reduce the overall volume level before you cancel the karaoke function. This is because the MASTER VOLUME level is not reduced when you adjust the MUSIC VOLUME.

**■ Music tone****Turn Music Tone knobs to adjust the music tone level.**

You can adjust the music tone level in 3 bands – Low, Medium and High.

## Advanced karaoke settings

### Using the KARAOKE menu to adjust the karaoke settings

You can adjust various karaoke settings using the KARAOKE menu.

Use the remote for the operation.

- 1 Press MAIN MENU repeatedly to select “<KARA>”.**
- 2 Press  $\uparrow$  or  $\downarrow$  repeatedly to select the parameter you want to adjust.**  
For details, see “KARAOKE menu parameters” on page 25.
- 3 Press  $\leftarrow$  or  $\rightarrow$  repeatedly to select the setting you want.**  
The setting is entered automatically.
- 4 Repeat steps 2 and 3 to adjust the other items.**

### KARAOKE menu parameters

**■ KARA XXX (Karaoke on/off)**

Initial setting: OFF

Select “ON” to activate the karaoke function.

**The following parameters are valid only when you have activated the karaoke function.**

The initial setting is underlined.

## ■ XXXXXXXX (Vocal select)

Lets you select the vocal type you want when singing karaoke.

- **VOCAL ST.** (Vocal stereo)

You can hear the original stereo sound.

- **VOCAL L** (Vocal left)

Left channel sound is output from both front speakers when you play a multiplex disc.

- **VOCAL R** (Vocal right)

Right channel sound is output from both front speakers when you play a multiplex disc.

- **V. OFF** (Vocal off)

The vocal is cut off.

- **V. ASSIST** (Vocal assist)

You can hear the vocal when you stop singing using the microphone for few seconds during a song. However, the vocal will be automatically cut off when you resume singing.

### Tips

- You can also use the VOCAL SELECT button on the receiver.
- If you sing along with a multiplex disc, we recommend you to set the vocal select to “VOCAL L” or “VOCAL R”.
- The VOCAL SELECT indicator lights up when you select any setting except “VOCAL ST.”.

### Notes

- Depending on the audio format of the disc, the vocal may not be cut off perfectly even though you have set the vocal select to “V. OFF”. In this case, select the audio format you want on the connected component. For details, please refer to the operating instructions supplied with the connected component.
- The vocal may not be cut off perfectly when
  - only a few instruments are playing.
  - a duet is being played back.
  - the source has strong echoes or chorus.
  - the vocal deviates from center.
  - the voice on the source is singing in high soprano or tenor.

## ■ KEY XX (Key control)

Lets you change the pitch of the music to suit your vocal range.

Initial setting: 0

You can adjust the key from -6 to +6 in 13 steps.

### Tip

You can also use the KEY CONTROL **#/b** button on the receiver.

### Notes

- This parameter is valid only when
  - the speaker setting is 2 channel, or
  - you use a sound field selected with 2CH button (2CH STEREO mode).
- The key control will reset to initial setting (0) when
  - no sound is output for more than few seconds.
  - you turn off the karaoke function.
  - you select another input.
  - you turn off the power.
  - the MUSIC VOLUME level is too low.
  - you use a sound field selected with MOVIE or MUSIC button.
  - the input source is other than 2 channel.

## ■ SCORE X (Scoring system on/off)

Lets you know the score from singing a song.

This score calculation is based on 2 criteria:

- Comparison between the pitch of the voice input through microphone to the original vocal.
- Voice level input through the microphone.
- **N (Off)**  
The scoring system is not activated.
- **Y (On)**  
The scoring system is activated. A few seconds after you finish singing a song, the score will appear in the display.

### Tips

- You can also use the SCORE button on the receiver.
- You can also view your score by pressing DISPLAY on the receiver.
- If you sing along with a AUDIO CD or any 2 channel stereo sources, we recommend you to set the vocal select to “V. OFF” or “V. ASSIST”. Then, the scoring system will perform effectively.

### Notes

- If the music volume level is too low, your score will appear in the display even though you have not finish singing a song. In this case, cancel the scoring system.
- Depending on the input source, the score calculation may be different from expectation.

# Switching the audio input mode for digital components

### — INPUT MODE

You can switch the audio input mode for components which have digital audio input jacks.

- 1 Turn **INPUT SELECTOR** to select the input.
- 2 Press **INPUT MODE** repeatedly to select the audio input mode.

The selected audio input mode appears in the display.

### Audio input modes

#### ■ AUTO IN

Gives priority to digital signals when there are both digital and analog connections. If there are no digital signals, analog is selected.

#### ■ COAX IN

Specifies the digital audio signals input to the DIGITAL COAXIAL input jack.

#### ■ OPT IN

Specifies the digital audio signals input to the DIGITAL OPTICAL input jacks.

#### ■ ANALOG

Specifies the analog audio signals input to the AUDIO IN (L/R) jacks.

#### Notes

- When signals with a sampling frequency of more than 48 kHz is input, the D.B.F.B. (Dynamic Bass Feedback) and sound field cannot be used.
- Some audio input modes may be dimmed depending on the input. This means that the selected input is unavailable.

## Customizing sound fields

By adjusting the LEVEL menu, you can customize the sound fields to suit your particular listening situation.

### Note on the displayed items

The setup items you can adjust in each menu vary depending on the sound field. Certain setup parameters may be dimmed in the display. This means that the selected parameter is either unavailable or fixed and unchangeable.

### Adjusting the LEVEL menu

You can adjust the balance and level of each speaker. These settings are applied to all sound fields except for effect level parameter. The effect level parameter settings are stored individually for each sound field.

Use the remote for the operation.

- 1 Start playing a source encoded with multi channel surround effects (DVD, etc.).
- 2 Press **MAIN MENU** repeatedly to select “<LEVEL>”.
- 3 Press **↑** or **↓** repeatedly to select the parameter you want to adjust.  
For details, see “LEVEL menu parameters” on page 28.
- 4 While monitoring the sound, press **←** or **→** repeatedly to select the setting you want.  
The setting is entered automatically.
- 5 Repeat steps 3 and 4 to adjust the other parameters.

## LEVEL menu parameters

The initial setting is underlined>.

### ■ **BAL. L/R XX** (Front speaker balance)

Initial setting: BALANCE (0)

Lets you adjust the balance between front left and right speakers. You can adjust in the range of BAL. L (+1 to +8), BALANCE (0), BAL. R (+1 to +8) in 17 steps.

### ■ **CTR XXX dB** (Center speaker level)

### ■ **SUR.L. XXX dB** (Surround speaker (left) level)

### ■ **SUR.R. XXX dB** (Surround speaker (right) level)

### ■ **S.W. XXX dB** (Sub woofer level)

Initial setting: 0 dB

You can adjust from -10 dB to +10 dB in 1 dB steps.

### ■ **D.B.F.B. XXX** (Dynamic Bass Feedback)

Lets you reinforce the bass and treble of the selected input.

- ON

The front speaker's bass and treble level are reinforced.

- OFF

The front speaker's bass and treble level are not reinforced.

#### Tips

- You can also use the D.B.F.B. button on the receiver.
- When the Dynamic Bass Feedback is activated, the D.B.F.B. indicator lights up.

#### Note

This parameter is not valid when PCM 96 kHz signal is input.

### ■ **COMP. XXX** (Dynamic range compressor)

Lets you compress the dynamic range of the sound track. This may be useful when you want to watch movies at low volumes late at night.

- OFF

The dynamic range is not compressed.

- STD

The dynamic range is compressed as intended by the recording engineer.

- MAX

The dynamic range is compressed dramatically.

#### Tip

Dynamic range compressor lets you compress the dynamic range of the soundtrack based on the dynamic range information included in the Dolby Digital signal. "COMP. STD" is the standard setting, but it only enacts light compression. Therefore, we recommend using the "COMP. MAX" setting. This greatly compresses the dynamic range and lets you view movies late at night at low volumes. Unlike analog limiters, the levels are predetermined and provide a very natural compression.

#### Note

Dynamic range compression is possible with Dolby Digital sources only.

### ■ **EFCT. XXX (Effect level)**

Initial setting: STD

Lets you adjust the "presence" of the surround effect in 3 levels - MIN (minimum effect), STD (standard effect) and MAX (maximum effect).

#### Note

This parameter is valid only when you use a sound field selected with the MOVIE or MUSIC button.

---

## Resetting sound fields to the initial settings

Use the buttons on the receiver for the operation.

**1** Press **I/⏻** to turn off the power.

**2** While holding down **2CH**, press **I/⏻**.

"SF. CLR." appears in the display and all sound fields are reset to the initial setting.

## Advanced settings

### Using the CUSTOMIZE menu to adjust the receiver

You can adjust various receiver settings using the CUSTOMIZE menu.

Use the remote for the operation.

**1** Press **MAIN MENU** repeatedly to select “<CUSTOM>”.

**2** Press **↑** or **↓** repeatedly to select the parameter you want to adjust.

For details, see “CUSTOMIZE menu parameters” on page 29.

**3** Press **←** or **→** repeatedly to select the setting you want.

The setting is entered automatically.

**4** Repeat steps 2 and 3 to adjust the other items.

### CUSTOMIZE menu parameters

The initial setting is underlined.

#### ■ **A.V.SYNC. X** (Time alignment)

- **Y** (Yes) (delay time : 68 ms)  
The audio output is delayed so that the time gap between the audio output and visual display is minimized.
- **N** (No) (delay time : 0 ms)  
The audio output is not delayed.

#### Notes

- This parameter is useful when you use a large LCD or Plasma monitor or projection TV.
- This parameter is only valid when you use a sound field selected with the 2CH or A.F.D. buttons.
- This parameter is not valid when PCM 96 kHz or DTS 2048 signals are input.

#### ■ **DEC. XXXX** (Digital audio input decoding priority)

Lets you specify the input mode for the digital signal input to the DIGITAL IN jacks.

- **AUTO**  
Automatically switches the input mode between DTS, Dolby Digital, or PCM.
- **PCM**  
PCM signals are given priority (to prevent the interruption when playback starts). Even when other signals are input, the sound is output. However, this receiver cannot decode DTS-CD when set to “DEC. PCM”.

#### Note

When set to “DEC. AUTO” and the sound from the digital audio jacks (for CD, etc.) is interrupted when playback starts, set to “DEC. PCM”.

#### ■ **DUAL XXX** (Digital broadcast language selection)

Lets you select the language you want to listen to during digital broadcast. This feature only functions for Dolby Digital sources.

- **M/S** (Main/Sub)  
Sound of the main language will be output through the front left speaker and sound of the sub language will be output through the front right speaker simultaneously.
- **M** (Main)  
Sound of the main language will be output.
- **S** (Sub)  
Sound of the sub language will be output.
- **M+S** (Main + Sub)  
Mixed sound of both the main and sub languages will be output.

#### ■ **[DIMMER]** (Brightness of the display)

Lets you adjust the brightness of the display in 3 steps.

#### ■ **NAME IN** (Naming the inputs)

Lets you set the name of inputs selected with the input buttons on the remote (except for TUNER). For details, see “Naming preset stations and inputs” on page 30.

## Other Operations

### Naming preset stations and inputs

You can enter a name of up to 8 characters for preset stations and inputs selected with the input buttons, and display it in the receiver's display. Use the remote for the operation.

#### 1 To index a preset station

Press **TUNER** to select the FM or AM band, then tune in the preset station you want to create an index name for (page 19). Then, press **MAIN MENU** repeatedly to select "<TUNER>".

#### To index an input

Press the input button (**VIDEO 1**, **VIDEO 2**, **DVD** or **SA-CD/CD**) to select the input you want to create an index name for. Then, press **MAIN MENU** repeatedly to select "<CUSTOM>".

#### 2 Press **↑** or **↓** repeatedly to select "NAME IN".

#### 3 Press **ENTER**.

The cursor flashes and you can select a character.

#### 4 Use **↑** or **↓** and **←** or **→** to create an index name.

Press **↑** or **↓** repeatedly to select a character, then press **→** to move the cursor to the next position.

#### Tips

- You can select the character type as follows by pressing **↑** or **↓** repeatedly.  
Alphabet (upper case) → Numbers → Symbols
- To enter a blank space, press **↑** or **↓** repeatedly until a blank space appears in the display.
- If you made a mistake, press **←** or **→** repeatedly until the character you want to change flashes, then press **↑** or **↓** repeatedly to select the correct character.

#### 5 Press **ENTER** to store the index name.

## Using the Sleep Timer

You can set the receiver to turn off automatically at a specified time.

Use the remote for the operation.

#### Press **SLEEP** while the power is on.

Each time you press **SLEEP**, the display changes cyclically as follows:

2-00-00 → 1-30-00 → 1-00-00 →

0-30-00 → OFF

While using Sleep Timer, "SLEEP" lights up in the display.

#### Tip

To check the remaining time before the receiver turns off, press **SLEEP**. The remaining time appears in the display. If you press **SLEEP** again, the sleep timer will be canceled.

## Enjoying the lighting effects

You can create a party environment using the D-LIGHT SYNC OUT jack on this receiver.

**Connect the lighting devices (not supplied) to the D-LIGHT SYNC OUT jack using the D-LIGHT SYNC Controller (DLS-1) (not supplied).**

The D-LIGHT SYNC Controller will synchronize the lighting effects to the music's rhythm.

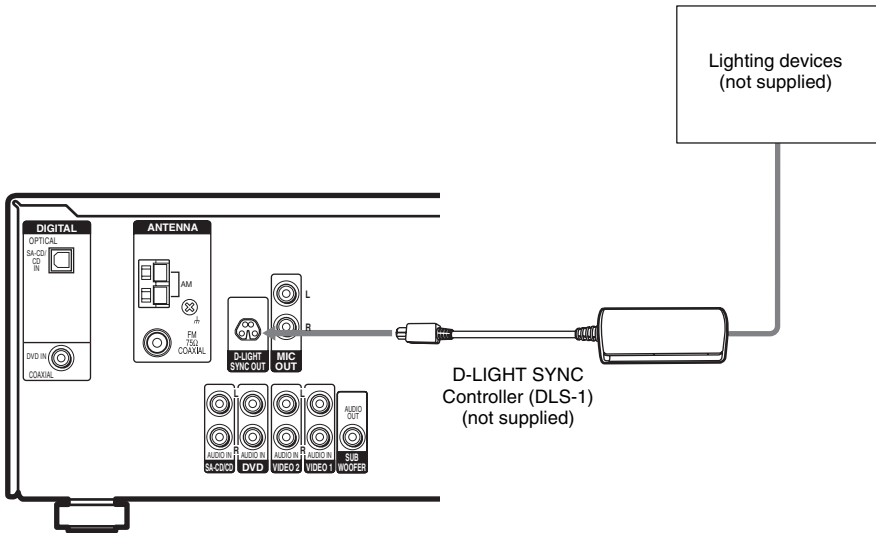

For details on the use of the D-LIGHT SYNC Controller and the lighting devices, refer to operating instructions supplied with the respective devices.

## Optional karaoke scoring system

If you have a karaoke component with karaoke scoring system (for example, DVD-KARAOKE), you can view your karaoke score on your TV screen using the MIC OUT jack on this receiver.

**Connect the karaoke component to MIC OUT jack using an audio cord (not supplied).**

For details on the use of the karaoke component, refer to operating instructions supplied with the karaoke component.

### **Note**

You can use the MIC 1 and MIC 2 jacks simultaneously for this operation. The signal will be output from the MIC OUT jack to the connected karaoke component.



# Operations Using the Remote RM-AAU002

You can use the remote RM-AAU002 to operate the components in your system.

## Before you use your remote

### Inserting batteries into the remote

Insert R6 (size-AA) batteries with the + and - properly oriented in the battery compartment. When using the remote, point it at the remote sensor  on the receiver.

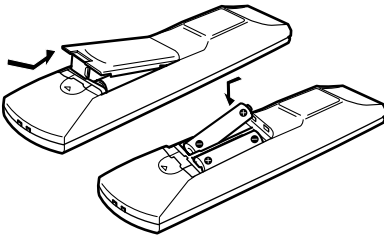

#### Tip

Under normal conditions, the batteries should last for about 6 months. When the remote no longer operates the receiver, replace all batteries with new ones.

#### Notes

- Do not leave the remote in an extremely hot or humid place.
- Do not use a new battery with an old one.
- Do not expose the remote sensor to direct sunlight or lighting apparatuses. Doing so may cause a malfunction.
- If you don't use the remote for an extended period of time, remove the batteries to avoid possible damage from battery leakage and corrosion.

## Remote button description

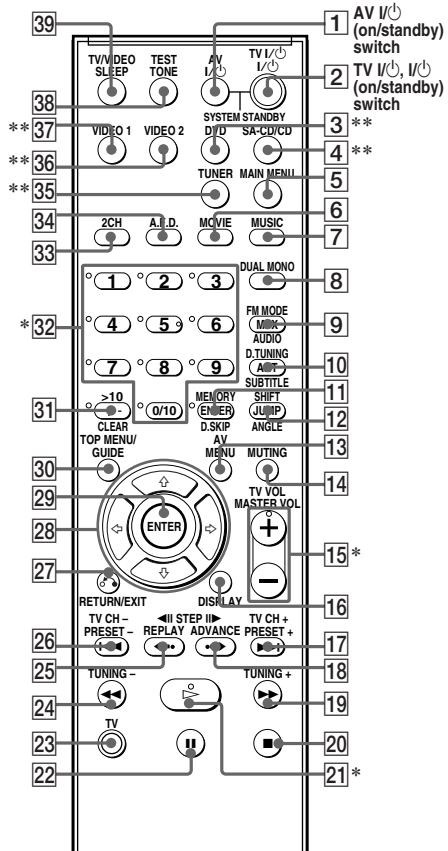

- \* The MASTER VOL +, numeric button 5 and  buttons have a tactile dot. Use the tactile dot as a reference when operating the receiver and other audio/video components.
- \*\* Input buttons

The tables below show the settings of each button.

Remote Button	Operations	Function
A.F.D. <b>34</b>	Receiver	Selects the decoding mode for audio sound.
ANGLE <b>12</b>	DVD player	Selects viewing angle or changes the angles.
ANT <b>10</b>	VCR/ Satellite tuner	Selects output signal from the antenna terminal: TV signal or VCR program.
AUDIO <b>9</b>	DVD player/ Satellite tuner	Changes the sound to Multiplex, Bilingual or Multi channel TV sound.
AV MENU <b>13</b>	VCR/ DVD player/ Satellite tuner	Displays menu.
AV I/⏻ <b>1</b>	VCR/ CD player/ DVD player/ Satellite tuner/ MD deck	Turns the audio and video components on or off.
CLEAR <b>31</b>	DVD player/ Satellite tuner	Clears a mistake when you press the incorrect numeric buttons or returns to continuous playback etc.
DISPLAY <b>16</b>	Receiver/ VCR/ CD player/ DVD player/ Satellite tuner/ MD deck	Selects information displayed on the TV screen.
D.SKIP <b>11</b>	CD player/ DVD player	Skips discs (multi-disc changer only).
D.TUNING <b>10</b>	Receiver	Enters direct tuning mode.
DUAL MONO <b>8</b>	Receiver	Selects the language you want during digital broadcast.
DVD <b>3</b>	Receiver	To watch DVD.
ENTER <b>11</b>	TV/VCR/ Satellite tuner	After selecting a channel, disc or track using the numeric buttons, press to enter the value.

Remote Button	Operations	Function
ENTER <b>29</b>	Receiver/ VCR/ CD player/ DVD player/ Satellite tuner/ MD deck	Enters the selection.
FM MODE <b>9</b>	Receiver	Selects FM monaural or stereo reception.
JUMP <b>12</b>	Satellite tuner	Toggles between the previous and the current channels.
MAIN MENU <b>5</b>	Receiver	Selects the menu of the receiver.
MASTER VOL +/- <b>15</b>	Receiver/TV	Adjusts the master volume of the receiver.
MEMORY <b>11</b>	Receiver	Stores the radio stations.
MOVIE <b>6</b>	Receiver	Selects the pre-programmed sound fields for movie.
MPX <b>9</b>	VCR	Select main or sub language.
MUSIC <b>7</b>	Receiver	Selects the pre-programmed sound fields for music.
MUTING <b>14</b>	Receiver	Mutes the sound from the receiver.
PRESET +/- <b>17 26</b>	Receiver	Selects preset stations.
	TV/VCR/ Satellite tuner	Select preset channel.
RETURN/ EXIT <b>27</b>	DVD player	Returns to the previous menu.
	Satellite tuner	Exits the menu.
SA-CD/CD <b>4</b>	Receiver	To listen to Super Audio CD or compact disc.
SHIFT <b>12</b>	Receiver	Selects a memory page for presetting radio stations or tuning to preset stations.

Remote Button	Operations	Function
SLEEP <b>39</b>	Receiver	Activates the sleep function and the duration which the receiver turns off automatically.
SUBTITLE <b>10</b>	DVD player	Changes the subtitles.
SYSTEM STANDBY (Press AV I/⏻ <b>1</b> and I/⏻ <b>2</b> at the same time)	Receiver/ TV/VCR/ CD player/ DVD player/ Satellite tuner/ MD deck	Turns off the receiver and other Sony audio/ video components.
TEST TONE <b>38</b>	Receiver	Outputs test tone.
TOP MENU/ GUIDE <b>30</b>	DVD player	Displays DVD title.
	Satellite tuner	Display guide menu.
TUNER <b>35</b>	Receiver	To listen to radio programs.
TUNING +/- <b>19</b> <b>24</b>	Receiver	Scans radio station.
TV <b>23</b>	TV	To watch TV programs.
TV CH +/- <b>17</b> <b>26</b>	TV	Selects preset TV channels.
TV/VIDEO <b>39</b>	TV	Selects input signal: TV input or video input.
TV VOL +/- <b>15</b>	TV	Adjusts the volume of the TV.
TV I/⏻ <b>2</b>	TV	Turns the TV on or off.
VIDEO 1 <b>37</b>	Receiver	To watch VCR. (VTR mode 3)
VIDEO 2 <b>36</b>	Receiver	To watch VCR. (VTR mode 1)

Remote Button	Operations	Function
1-9 and 0/10 <b>32</b>	Receiver	Use with SHIFT to preset radio station or tuning to preset stations and with D.TUNING for direct tuning.
	CD player/ DVD player/ MD deck	Selects track numbers. 0/10 selects track 10.
	TV/ VCR/ Satellite tuner	Selects channel numbers.
2CH <b>33</b>	Receiver	Selects 2CH STEREO mode.
>10 <b>31</b>	VCR/ CD player/ Satellite tuner/ MD deck	Selects track numbers over 10.
-/- <b>31</b>	TV	Selects the channel entry mode, either one or two digit.
I/⏻ <b>2</b>	Receiver	Turns the receiver on or off.
◀◀ STEP ▶▶ REPLAY ◀•/ ▶▶ ADVANCE •▶ <b>25</b> <b>18</b>	VCR/ DVD player	Replay the previous scene or fast forward the current scene.
◀◀/▶▶ <b>26</b> <b>17</b>	CD player/ DVD player/ MD deck/ Tape deck	Skips tracks.
◀◀/▶▶ <b>24</b> <b>19</b>	DVD player	Searches tracks in the forward or backward direction.
	VCR/ CD player/ MD deck/ Tape deck	Fastforwards or rewinds.
▷ <b>21</b>	VCR/ CD player/ DVD player/ MD deck/ Tape deck	Starts playback.

Remote Button	Operations	Function
22	VCR/ CD player/ DVD player/ MD deck/ Tape deck	Pauses playback or recording. (Also starts recording with components in recording standby.)
20	VCR/ CD player/ DVD player/ MD deck/ Tape deck	Stops playback.
27	DVD player	Returns to the previous menu or exits the menu.
28	Receiver	Selects a menu item.
28	Receiver	Adjusts or changes the setting.
28	VCR/ Satellite tuner/ DVD player	Selects a menu item.

### Tips

- To activate the buttons with orange printing, press TV and the button you want simultaneously.
- Before you use the button for receiver operation, press MAIN MENU. To operate other components, press TOP MENU/GUIDE or AV MENU after pressing the input button.

### Notes

- Some functions explained in this section may not work depending on the model.
- The above explanation is intended to serve as an example only. Therefore, depending on the component the above operation may not be possible or may operate differently than described.
- When you press input buttons (VIDEO 1, VIDEO 2 or DVD), the input mode of the TV might not switch to the corresponding input mode that you want. In this case, press TV/VIDEO button to switch the input mode of the TV.

## Changing the factory setting of an input button

If the factory settings of the input buttons do not match your system components, you can change them. For example, if you have a CD player and you do not have a DVD player, you can assign the DVD button to your CD player.

- 1 Hold down the input button whose input you want to change (for example, DVD).**
- 2 Press the corresponding button of the component you want to assign to the input button (for example, 5 – CD player).**

The following buttons are assigned to select the input:

To operate	Press
VCR (command mode VTR 3*)	1
VCR (command mode VTR 2*)	2
DVD player or DVD recorder (command mode DVD1)	3
DVD recorder (command mode DVD3)	4
CD player	5
MD deck	6
Tape deck B	7
Tuner (this receiver)	8
DSS (Digital Satellite Receiver)	9
DCS (Digital CS Tuner)	0/10
BSD (Digital BS Tuner)	-/-

\*Sony VCRs are operated with a VTR 2 or 3 setting. These correspond to 8 mm and VHS respectively.

Now you can use the DVD button to control the CD player.

### To reset a button to its factory setting

Repeat the above procedure.

### To reset all the input buttons to their factory setting

Press I/⏻, TEST TONE and MASTER VOL – at the same time.

## Additional Information

### Precautions

#### On safety

Should any solid object or liquid fall into the cabinet, unplug the receiver and have it checked by qualified personnel before operating it any further.

#### On power sources

- Before operating the receiver, check that the operating voltage is identical with your local power supply. The operating voltage is indicated on the nameplate at the rear of the receiver.
- The receiver is not disconnected from the AC power source (mains) as long as it is connected to the wall outlet, even if the receiver itself has been turned off.
- If you are not going to use the receiver for a long time, be sure to disconnect the receiver from the wall outlet. To disconnect the AC power cord, grasp the plug itself; never pull the cord.
- AC power cord must be changed only at the qualified service shop.

#### On heat buildup

Although the receiver heats up during operation, this is not a malfunction. If you continuously use this receiver at a large volume, the cabinet temperature of the top, side and bottom rises considerably. To avoid burning yourself, do not touch the cabinet.

#### On placement

- Place the receiver in a location with adequate ventilation to prevent heat buildup and prolong the life of the receiver.
- Do not place the receiver near heat sources, or in a place subject to direct sunlight, excessive dust or mechanical shock.
- Do not place anything on top of the cabinet that might block the ventilation holes and cause malfunctions.
- Use caution when placing the receiver on surfaces that have been specially treated (with wax, oil, polish, etc.) as staining or discoloration of the surface may result.

#### On operation

Before connecting other components, be sure to turn off and unplug the receiver.

#### On cleaning

Clean the cabinet, panel and controls with a soft cloth slightly moistened with a mild detergent solution. Do not use any type of abrasive pad, scouring powder or solvent such as alcohol or benzine.

If you have any question or problem concerning your receiver, please consult your nearest Sony dealer.

# Troubleshooting

If you experience any of the following difficulties while using the receiver, use this troubleshooting guide to help you remedy the problem.

---

## **There is no sound or only a very low-level sound no matter which component is selected.**

- Check that the speakers and components are connected securely and correctly.
- Check that both the receiver and all components are turned on.
- Check that you have selected the correct component on the receiver.
- Check that MASTER VOLUME is not set at “VOL MIN”.
- Press MUTING on the remote to cancel the muting function.

---

## **There is no sound from a specific component.**

- Check that the component is connected correctly to the audio input jacks for that component.
- Check that the cord(s) used for the connection is (are) fully inserted into the jacks on both the receiver and the component.
- Check that you have selected the correct component on the receiver.

---

## **There is no sound from analog 2 channel sources.**

- Check that the INPUT MODE is not set to “COAX IN” or “OPT IN” (page 27).

---

## **There is no sound from digital sources (from COAXIAL or OPTICAL input jack).**

- Check that the INPUT MODE is not set to “ANALOG” (page 27). Check that the INPUT MODE is not set to “COAX IN” for the sources from OPTICAL input jack, or set to “OPT IN” for the sources from COAXIAL input jack.

---

## **The left and right sounds are unbalanced or reversed.**

- Check that the speakers and components are connected correctly and securely.
- Adjust balance parameters in the LEVEL menu.

---

## **There is severe hum or noise.**

- Check that the speakers and components are connected securely.
- Check that the connecting cords are away from a transformer or motor, and at least 3 meters away from a TV set or fluorescent light.
- Move your audio components away from the TV.
- The plugs and jacks are dirty. Wipe them with a cloth slightly moistened with alcohol.

---

## **There is no sound or only a very low-level sound is heard from the center or/and surround speakers.**

- Select a CINEMA STUDIO EX mode (page 22).
- Adjust the speaker level (page 16).
- Make sure the center/surround speakers size parameter are set to either “SMALL” or “LARGE” (page 14).

---

## **There is no sound from the sub woofer.**

- Make sure you have turn on your sub woofer.
- Check that the sub woofer is connected correctly and securely.
- Make sure the sub woofer selection parameter is set to “YES” (page 13).
- There is no sound output from the sub woofer depending on the sound field.

---

## **The surround effect cannot be obtained.**

- Make sure the sound field function is on (press MOVIE or MUSIC).
- Sound fields do not function for the signals with a sampling frequency of more than 48 kHz.

---

## **Dolby Digital or DTS multi channel sound is not reproduced.**

- Check that the playing DVD, etc. is recorded in Dolby Digital or DTS format.
- When connecting the DVD player, etc. to the digital input jacks of this receiver, check the audio setting (settings for the audio output) of the connected component.

---

### The FM reception is poor.

- Use a 75-ohm coaxial cable (not supplied) to connect the receiver to an outdoor FM antenna as shown below. If you connect the receiver to an outdoor antenna, ground it against lightning. To prevent a gas explosion, do not connect the ground wire to a gas pipe.

Outdoor FM antenna

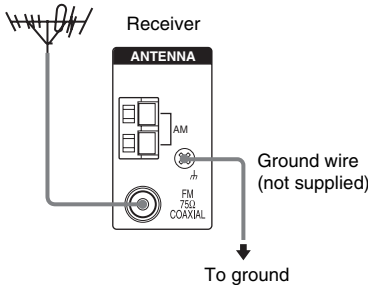

---

### Radio stations cannot be tuned in.



- Check that the antennas are connected securely. Adjust the antennas and connect an external antenna if necessary.
  - The signal strength of the stations is too weak (when tuning in with automatic tuning). Use direct tuning (page 18).
  - Make sure you set the tuning interval correctly (when tuning in AM stations with direct tuning).
  - No stations have been preset or the preset stations have been cleared (when tuning by scanning preset stations). Preset the stations (page 18).
  - Press DISPLAY repeatedly so that the frequency appears in the display.
- 

---

## Remote control

---

### The remote does not function.

- Point the remote at the remote sensor  on the receiver.
  - Remove any obstacles in the path between the remote and the receiver.
  - Replace all the batteries in the remote with new ones, if they are weak.
  - Make sure you select the correct input on the remote.
  - To activate the buttons with orange printing, press TV and the button you want simultaneously.
  - Before you use the  button for receiver operation, press MAIN MENU. To operate other components, press TOP MENU/GUIDE or AV MENU after pressing the input button.
- 

---

## Error messages

If there is a malfunction, the display shows a message. You can check the condition of the receiver by the message. Refer to the following table to solve the problem.

---

### DEC. ERROR

Appears when the signal which the receiver cannot decode (ex. DTS-CD) is input when "DEC. XXXX" in the CUSTOMIZE menu is set to "DEC. PCM". Set to "DEC. AUTO".

---

### PROTECT

Irregular current is output from the speakers. The receiver will automatically turn off after a few seconds. Check the speaker connection and turn on the power again. If this problem persists, consult your nearest Sony dealer.

---

## If you are unable to remedy the problem using the troubleshooting guide

Clearing the receiver's memory may remedy the problem. You can clear the receiver's memory by performing the following procedure. Use the buttons on the receiver for the operation.

### Notes

- All memorized settings will be reset to their factory settings and you will have to readjust all settings on the receiver.
- (Models of area code VN, TH only)  
The preset speaker settings is 2.0 channel. When you have initialized the receiver, the speaker settings will return to its initial setting 5.1 channel. Therefore, you need to readjust the speaker setup pattern (SP. PAT. X-X) in SETUP menu to "SP. PAT. 2-0" or according to your speaker combination (page 13).

**1 Press I/⏻ to turn off the receiver.**

**2 Hold down I/⏻ for 5 seconds.**

"PUSH" and "ENTER" appears in the display alternately.

**3 Press MEMORY/ENTER.**

"CLEARING" appears in the display for a while, then "CLEARED" appears.

The following are reset to their factory settings.

- All settings in the SETUP, KARAOKE, LEVEL, CUSTOMIZE and TUNER menus.
- The sound field memorized for each input and preset station.
- All sound field parameters.
- All preset stations.
- All index names for inputs and preset stations.
- MASTER VOLUME is set to "VOL MIN".
- MUSIC VOLUME is set to "MUSIC 0 dB".

### Tip

To clear customized sound fields, refer to "Resetting sound fields to the initial settings" on page 28.

## If the problem persists

Consult your nearest Sony dealer.

## Specifications

### Amplifier section

Power Output<sup>1)</sup>

Models of area code SP

(6 ohms 1 kHz, THD 0.7%)

FRONT<sup>2)</sup>: 80 W/ch

CENTER<sup>2)</sup>: 80 W

SURR<sup>2)</sup>: 80 W/ch

(6 ohms 1 kHz, THD 10%)

FRONT<sup>2)</sup>: 110 W/ch

CENTER<sup>2)</sup>: 110 W

SURR<sup>2)</sup>: 110 W/ch

Models of area code VN, TH

(6 ohms 1 kHz, THD 0.7%)

FRONT<sup>2)</sup>: 70 W/ch

CENTER<sup>2)</sup>: 70 W

SURR<sup>2)</sup>: 70 W/ch

(6 ohms 1 kHz, THD 10%)

FRONT<sup>2)</sup>: 95 W/ch

CENTER<sup>2)</sup>: 95 W

SURR<sup>2)</sup>: 95 W/ch

1) Measured under the following conditions:

Area code	Power requirements
SP	230 V AC, 50 Hz
VN, TH	220 V AC, 50 Hz

2) Depending on the sound field settings and the source, there may be no sound output.

Inputs (Analog)

SA-CD/CD, DVD,	Sensitivity: 800 mV
VIDEO 1, 2	Impedance: 50 k ohms

Inputs (Digital)

DVD (Coaxial)	Sensitivity: – Impedance: 75 ohms
SA-CD/CD (Optical)	Sensitivity: – Impedance: –

Output (Analog)

SUB WOOFER	Voltage: 2 V Impedance: 1 k ohm
------------	------------------------------------

Reproduction frequency range:

20 – 20,000 Hz



## FM tuner section

Tuning range	87.5 – 108.0 MHz
Antenna	FM wire antenna
Antenna terminals	75 ohms, unbalanced
Intermediate frequency	10.7 MHz

## AM tuner section

Tuning range	
Models of area code	SP, VN, TH
With 9-kHz tuning scale:	531 – 1,602 kHz
Antenna	Loop antenna
Intermediate frequency	450 kHz

## General

Power requirements

Area code	Power requirements
SP	230 – 240 V AC, 50/60 Hz
VN, TH	220 – 230 V AC, 50/60 Hz

Power consumption

Area code	Power consumption
SP, VN, TH	165 W

Power consumption (during standby mode)  
0.2 W

Dimensions (w/h/d) (Approx.)  
430 × 145 × 296 mm  
including projecting parts  
and controls

Mass (Approx.) 7.0 kg

## Supplied accessories

FM wire antenna (1)  
AM loop antenna (1)  
Remote commander RM-AAU002 (1)  
R6 (size-AA) batteries (2)

For details on the area code of the component you are using, see page 2.

Design and specifications are subject to change without notice.



# Index

## A

- Adjusting
  - CUSTOMIZE parameters 29
  - KARAOKE parameters 25
  - LEVEL parameters 27
  - SETUP parameters 13
  - speaker levels and balance 16
- Automatic tuning 17

## C

- Changing
  - display 19
- Clearing receiver's memory 40
- CUSTOMIZE menu 29

## D

- Digital Cinema Sound 22
- Direct tuning 18
- Dual Mono 29

## I

- Indexing. *See* Naming

## K

- Karaoke
  - adjusting the music 24
  - advanced settings 25
  - using karaoke 24
- KARAOKE menu 25

## L

- Labeling. *See* Naming
- LEVEL menu 27

## N

- Naming 30

## P

- Preset stations
  - how to 18
  - how to tune 19

## R

- Remote commander 33–36

## S

- Selecting
  - component 17
  - sound field 22–23
- SETUP menu 13
- Sleep Timer 30
- Sound field
  - customizing 27
  - pre-programmed 22–23
  - resetting 28
  - selecting 22–23
- Speaker crossover frequency 16
- Speakers
  - adjusting speaker levels and balance 16
  - connection 10
  - placement 10
- Supplied accessories 41

## T

- Test tone 16
- Tuning
  - automatically 17
  - directly 18
  - to preset stations 19

